

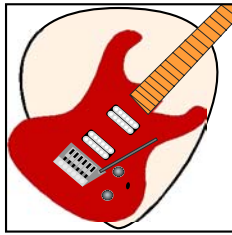

# Introduction Tuning and month one



# Introduction

In order for any guitar course to be successful,  
you must practise.  
practise practise practise practise practise practise

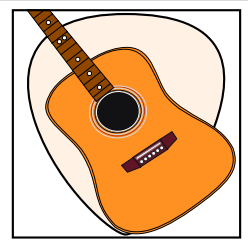

## Getting started

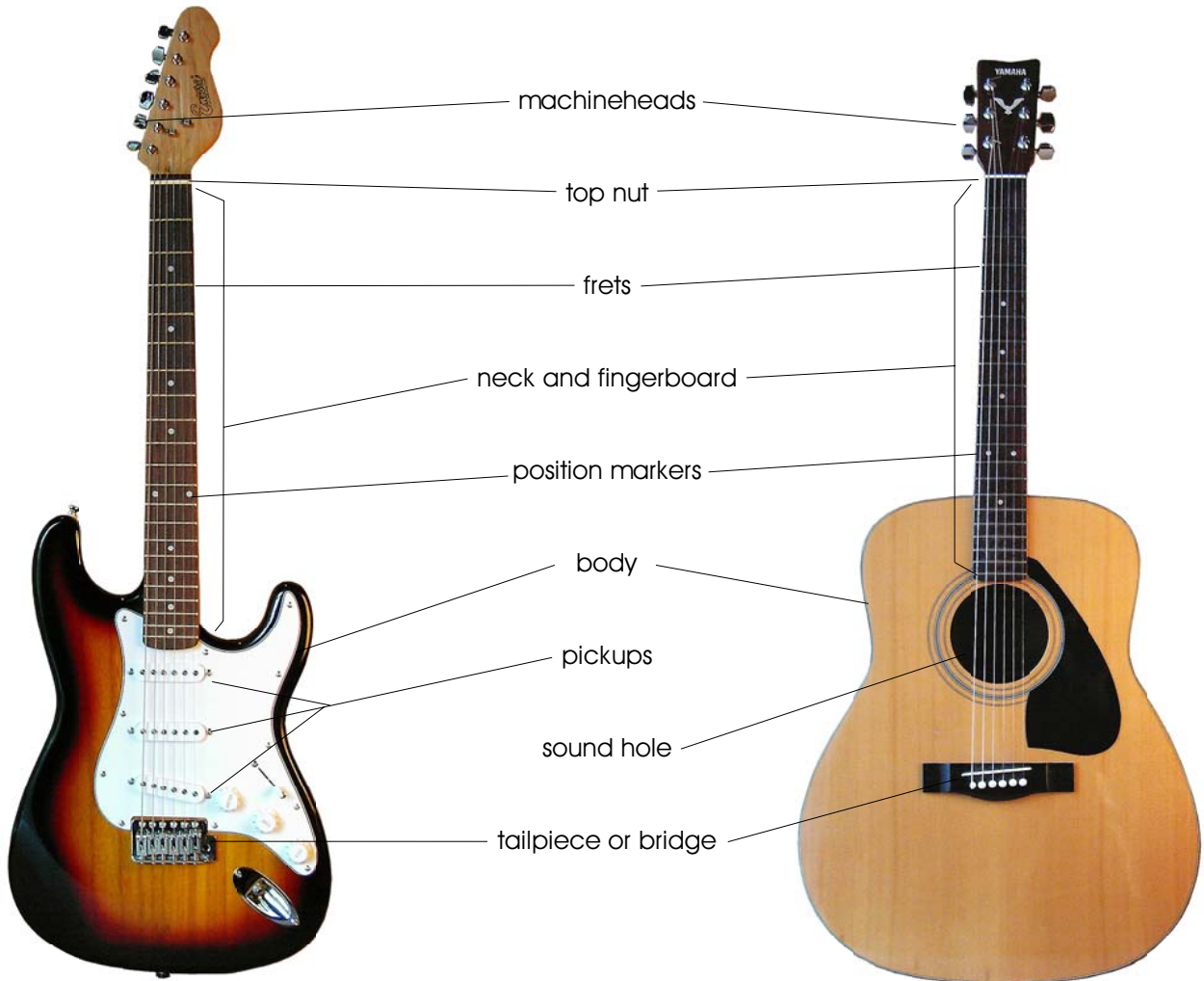

fingering map

left hand

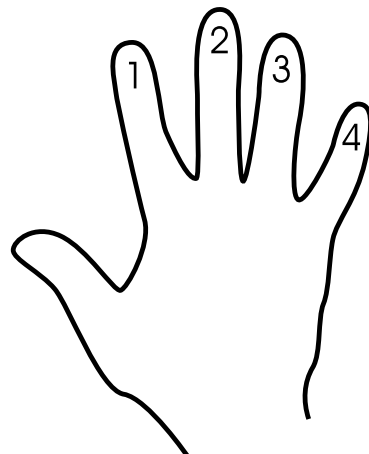
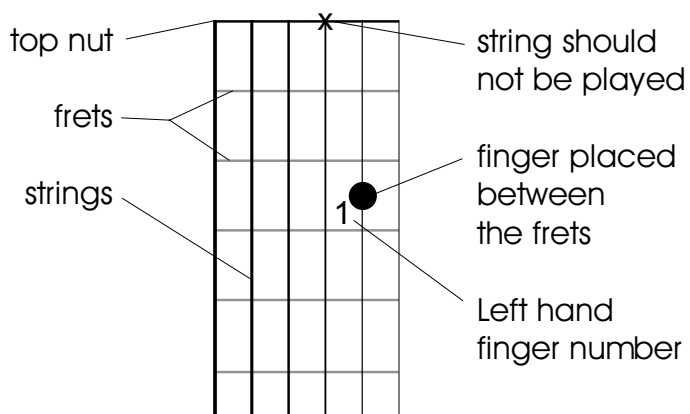

## fret map

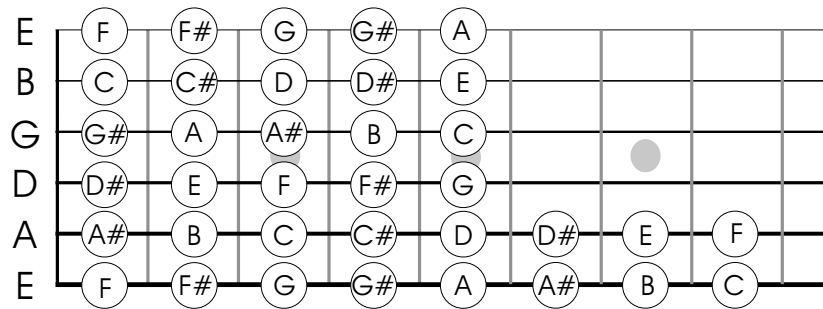

## Tuning

Before you start, it is important to tune your guitar. Even if you're playing correctly the guitar will sound wrong if it is out of tune. As time goes by you will start to recognize when your guitar is out of tune yourself. If you have a friend who can tune your guitar for you, it may be a good idea to let them do it for you until you become accustomed to the sound of the guitar. But if not don't worry.

There are many electronic tuners on the market that will tell you when your guitar is out of tune, or you can use tuning pipes or an electronic keyboard to get a reference note to tune from. We have provided a free tuner that will give you three different types of tones to tune your guitar from.

When tuning your guitar remember to turn your machineheads by very small amounts and re-pluck the string to see if it is tune, if you turn your machineheads to fast, to far, you will break your strings.

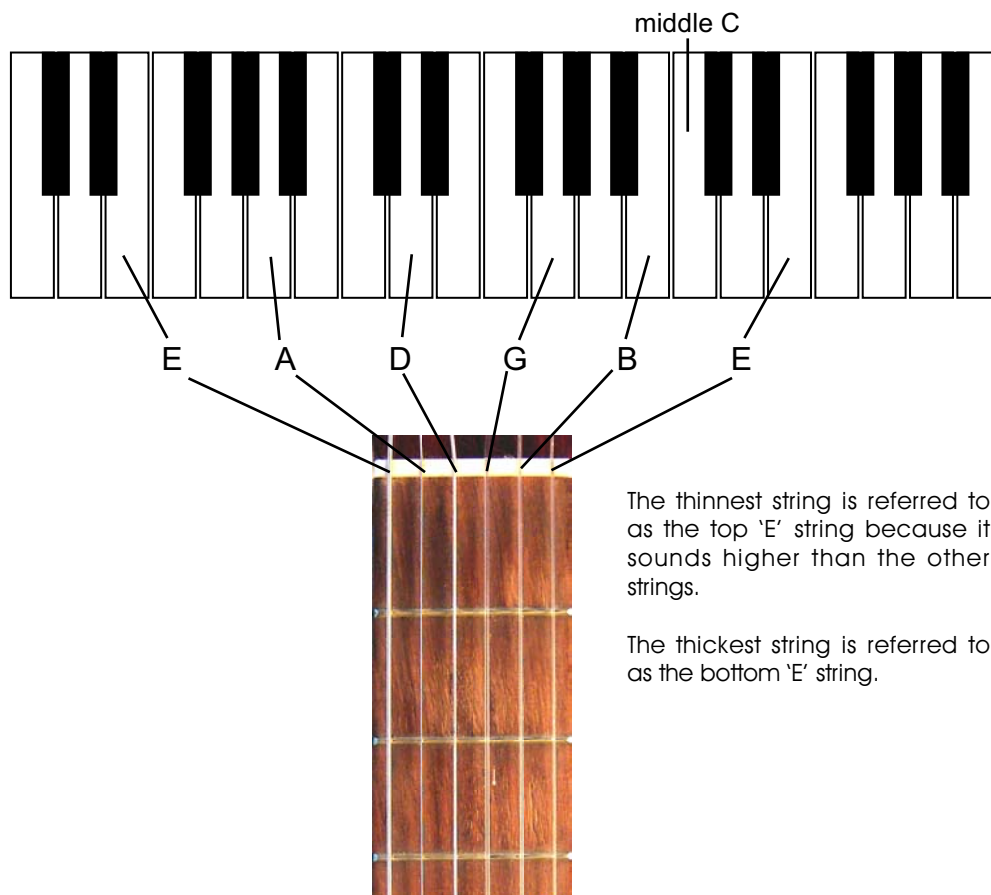

*Hint.* To remember the names of the strings you can use one of these silly sayings.

**Every Angry Dog Growls and Bites Eventually  
Elephants And Dogs God Blesses Everything**

# tuning the guitar to itself

Sometimes only a one or two strings will be out of tune or you may not have access to a reference note from which to tune your guitar. In either of these instances you can tune the guitar to itself, using the other strings as a reference point to tune from. This is the most common method for tuning guitars.

1. Until you have more experience of tuning your guitar you will need to use your tuner to get a string in tune, preferably, the top 'E' string.

2. Place your finger in the FIFTH fret of the next string down the 'B' string. Play this note shortly followed by the top 'E' string and repeat this several times. If the 'B' string is in tune, the two notes will sound the same. If the notes are different, then you will need to adjust the 'B' string and then repeat the process until the notes sound the same.

The 'B' string should now be in tune.

## IMPORTANT.

You are listening for the pitch of the notes. The tone of the note will always be a little different. Don't press too hard on the strings, because you can bend the string slightly making the note inaccurate.

3. Place your finger in the FOURTH fret of the next string down the 'G' string, and play this note shortly followed by the 'B' string and repeat this. If the 'G' string is in tune, the two notes will sound the same. If the notes are different, then you will need to adjust the 'G' string and then repeat the process until the notes sound the same. The 'G' string should now be in tune.

4. Place your finger in the FIFTH fret of the next string down the 'D' string, and play this note shortly followed by the 'G' string and repeat this. If the 'D' string is in tune, the two notes will sound the same. If the notes are different, then you will need to adjust the 'D' string and then repeat the process until the notes sound the same.

5. Repeat this pattern using the FIFTH fret for the last two strings.

6. Compare the top 'E' string and the bottom 'E' string. As they are both 'E', they are 'octaves' and have a unique sound. Firstly listen to them on free tuner provided as we know the tuner is in tune. Eventually you can use this sound as a double check, because if you have made a mistake on any of the other strings the two notes will not sound correct.

Tuning the 'E' string

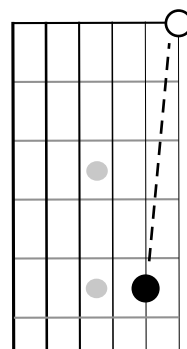

Tuning the 'B' string

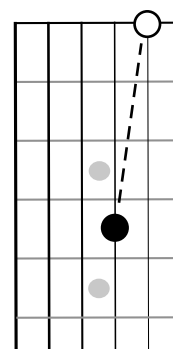

Tuning the 'D' string

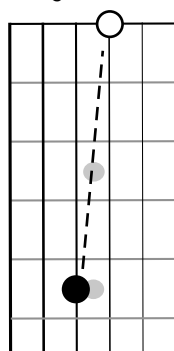

Tuning the 'A' string

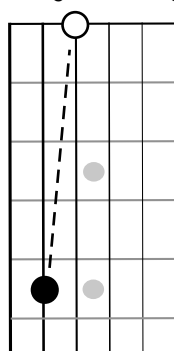

Tuning the 'E' string

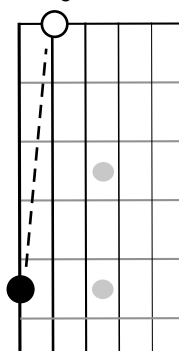

## The best way to learn to tune

Packaged with this course is a third party digital tuner, the Guitar Academy tuner and the tuner game.

1. Play the tuner game as many times as it takes for you to get 6 out of 6 several times. The tuner note and the guitar note have different tones to make the game more realistic.
2. Then tune your guitar with the Guitar Academy tuner, using the tuner notes as a reference point to tune your guitar to.
3. Finally check your guitar with the digital tuner. The digital tuner is the quickest and easiest way to tune, but if you only use the digital tuner it will be years before you hear tuning problems for yourself.

# using a pick (plectrum)

## How to hold your plectrum

There is no right or wrong way to hold your plectrum. Everyone will prefer their own style and sound of guitar music. There is however a standard method to work from, but don't feel you need to copy this method exactly but it does give a good starting point.

1. Bend your fingers into a fist.
2. Place the plectrum on the first knuckle of your index finger so that it points towards the guitar.
3. Hold the plectrum firmly in place using your thumb.

When playing with a pick the motion should come from the wrist, the whole arm should not move up and down. When strumming the motion comes more from the elbow.

For stability and to aid with locating the strings without needing to look down, some players either rest the hand or arm on the guitar. Another approach is to rest your fingers on the guitar, scratchplate or place your little finger on a pickup if you have an electric guitar.

## Which plectrum to use.

Plectrums come in all sorts of shapes and sizes, but you will find that they are usually marked with the thickness, which is helpful. Remember though that the thickness is just a guide, plectrums will play differently depending on what material they are made of. At this stage of your learning it is probably a good idea to buy a several to find out which one is best for you.

1mm is a common thickness of plectrum. It is a good all round plectrum.

Plectrums over 1mm will not bend very much, if at all. They produce a more bassy tone and they can be more difficult for strumming.

Plectrums under 0.7mm can bend a lot. They produce a brighter tone and are ideal for strumming as they are more forgiving if your plectrum accuracy isn't perfect.



## IMPORTANT

As you get used to your pick look at the position you're holding it in every time you practise. If the pick position changes every time you play it will take you a lot longer to get used to it.

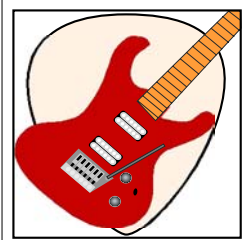

# Lesson One

## open chords

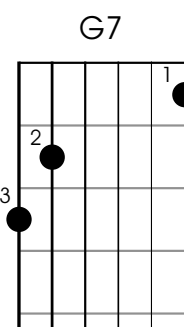
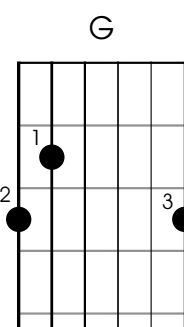
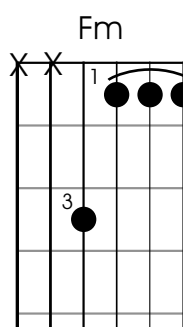
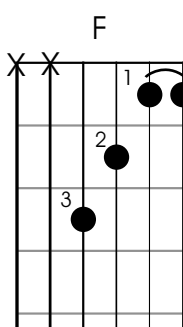
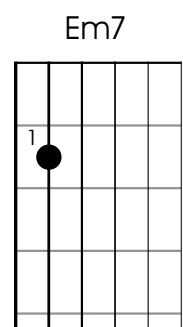
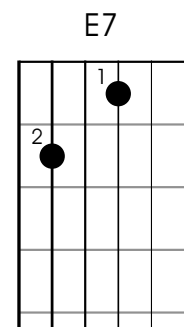
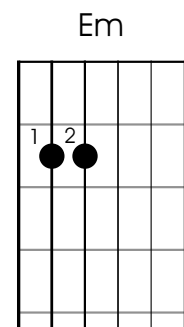
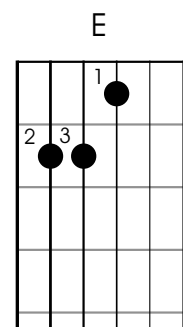
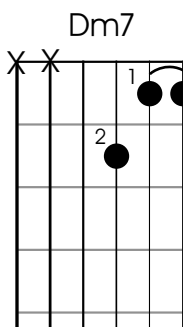
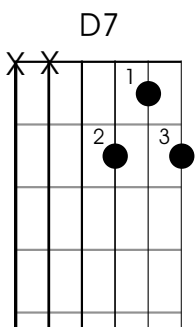
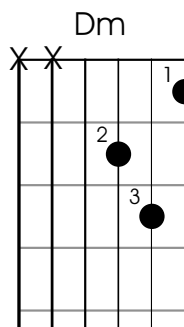
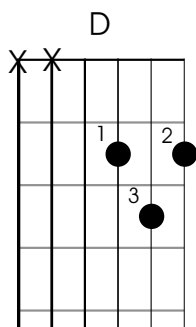
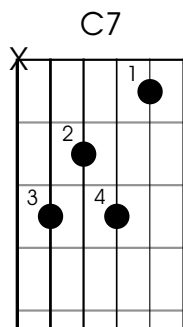
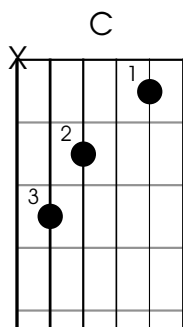
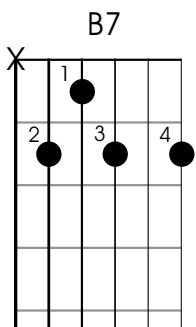
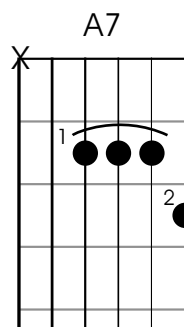
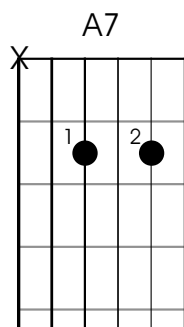
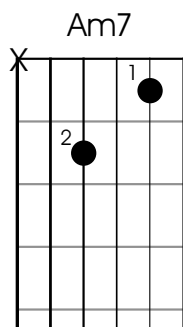
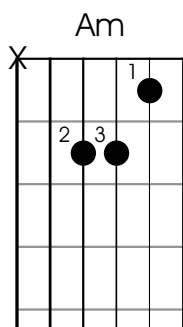
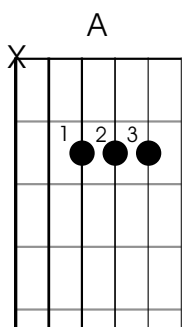
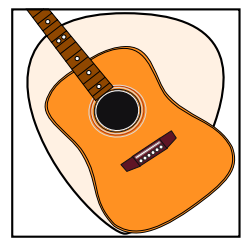

# exercises

Play the following open chord exercises.

Then repeat them until the chords sound clean and the changes sound smooth.

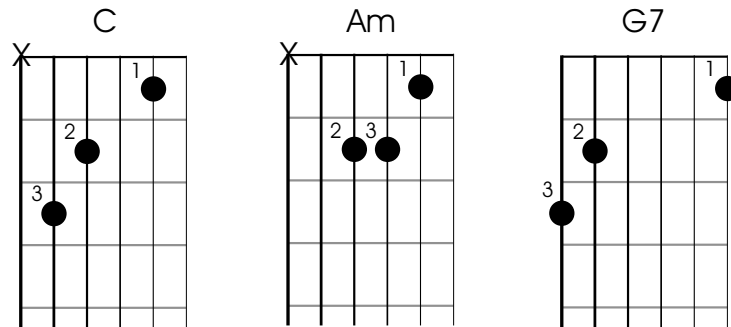

C - - - Am - - - C - - - Am - - - C - - - G7 - - - C - - - Am - - -

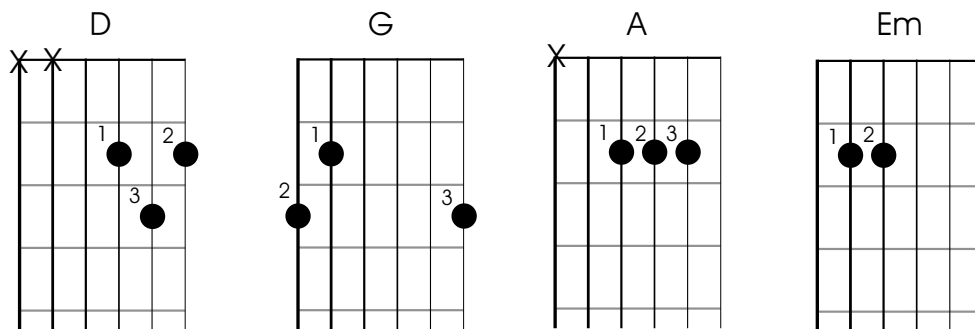

D - - - G - - - D - - - A - - - D - - - G - - - D - - - Em - - -

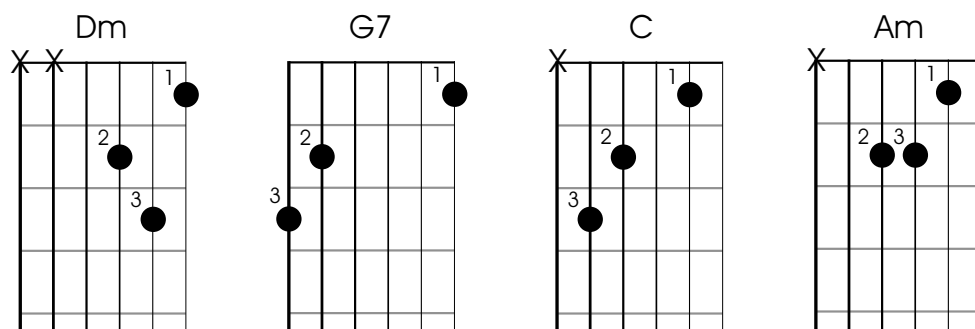

Dm - - - G7 - - - C - - - Am - - - Dm - - - G7 - - - C - - - C - - -

# tunes

## Introduction

Bellow is a BAR. A bar is a representation of time used in music, and all music is made up of bars. To start with, the bars we are using contain 4 beats (they are 4/4 time). It is important that the length of time for each bar remains the same and therefore I recommend downloading the metronome and practicing trying to play the chords as accurately as possible on the first beat of the bar.

	1	2	3	4
beats				
bar	G			

Try the following; 

G				G				G				G			
---	--	--	--	---	--	--	--	---	--	--	--	---	--	--	--

Remember that there is no break between the bars, every beat should remain the same, and therefore the beat should sound constant.

Sometimes you will find that there is more than one chord in a bar, in this instance play the second chord on the THIRD beat of the bar (for now). As you get better and start to play more advanced pieces, you will find any number of chords in a bar.

For example 

	1	2	3	4	1	2	3	4
D7		A7		A7				

## The arrangement

Every tune has an arrangement. An arrangement is the order in which a tune is played. For example, verse, chorus, verse, chorus. By listing arrangements the tunes are kept smaller, neater and easier to follow. You will also gain a better understanding of music for when you eventually want to write your own. Music can be made up of any number of sections in any order, here are some of the section names.

Intro (introduction), Verse, Chorus, Bridge, transition, Solo, Coda (end).

## Using the backing tracks

When using the backing tracks, remember to follow the beat of the drum rather than the tune and you find that you can play along. Even tunes that you don't know or are unfamiliar with shouldn't be a problem if you follow the beat. To start with you may have trouble keeping up, but with practise you will soon find that speed becomes less of an issue.

Here are some rules to help you play along with the backings.

1. There are always two bars before the music starts.
2. Follow the beats and not the tune.
3. If you miss a chord, leave it and try to join in later. Don't try to catch up.
4. Just strum the chord once, we will add rhythms later.
5. If you have trouble changing between two chords, practise the change.

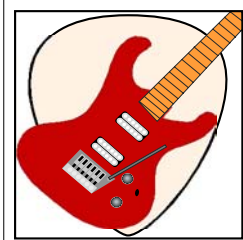

# month one

## Week One

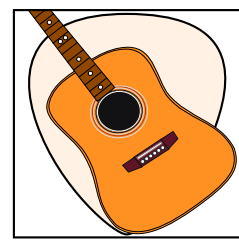

Now, lets try and put together some of what you have learned to play our first pieces of music. The two tunes bellow are in 4/4 time, so their are FOUR beats per bar.

1. Play the chords a few times until you are happy with the changes.
2. Try playing with the metronome in 4/4 time, using a slow setting (between 40 & 80)
3. Try playing with the backing tracks

### tune

She'll be coming 'round the mountain

G				G				G				D			
---	--	--	--	---	--	--	--	---	--	--	--	---	--	--	--

G				C				D				G			
---	--	--	--	---	--	--	--	---	--	--	--	---	--	--	--

### HEY JUDE - the beatles

verse

D				A				A				D			
---	--	--	--	---	--	--	--	---	--	--	--	---	--	--	--

G				D				A				D			
---	--	--	--	---	--	--	--	---	--	--	--	---	--	--	--

chorus

D7				G				Em				A7				D			
----	--	--	--	---	--	--	--	----	--	--	--	----	--	--	--	---	--	--	--

D7				G				Em				A7				D			
----	--	--	--	---	--	--	--	----	--	--	--	----	--	--	--	---	--	--	--

D7		A7		A7			
----	--	----	--	----	--	--	--

coda

D				C				G				D			
---	--	--	--	---	--	--	--	---	--	--	--	---	--	--	--

*repeat and fade*

arrangement

verse - verse - chorus - verse - coda

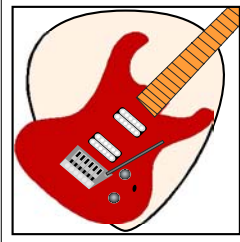

# month one Week Two

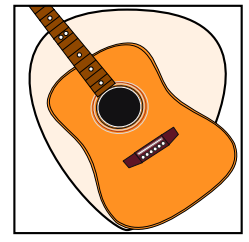

This tune is in 3/4 time, which basically means that there are THREE beats per bar. Try it with the metronome set on 3/4. The way to count for this piece will be as follows.

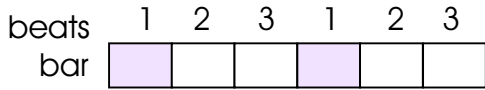

## Amazing Grace

G			G			C			G		
G			G			D7			D7		
G			G7			C			G		
G			D7			G			G		

## exercise - 'G' major scale

Scales are the DNA of music and everything you do when you play your guitar either directly involves the use of scales or has been derived from a scale. Scales are played as single notes in succession, however all the notes will be put together on a 'scale map' to help make the pattern more clear.

Play the following notes in order and then repeat, try to increase speed and flow.

### 'G' major scale map

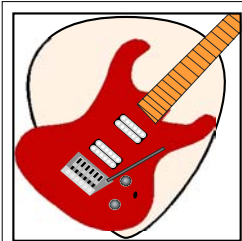

# month one

## Week Three

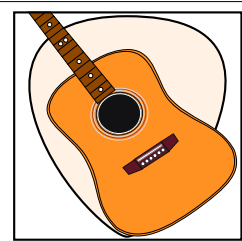

This first month needs to be spent mastering open chords. As you play different tunes with different combinations of chords, your changes and speed should improve.

1. Play the chords a few times until you are happy with the changes.
2. Play with the metronome in 4/4 time, using a slow setting (between 60 & 100)
3. Try playing with the backing tracks

### tune

Live Forever - Oasis

verse

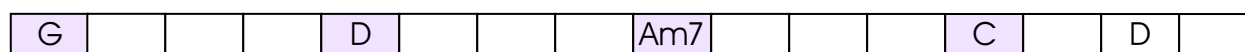
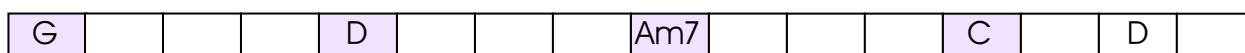

chorus

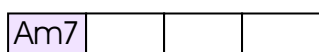
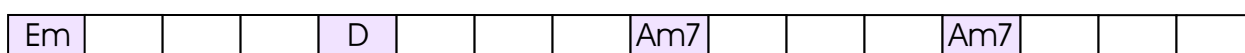
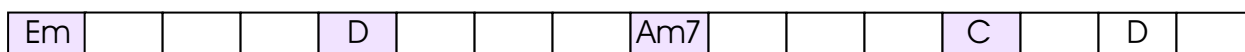

coda

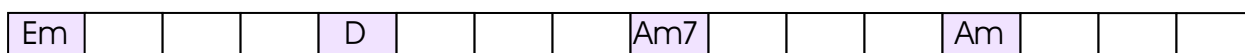
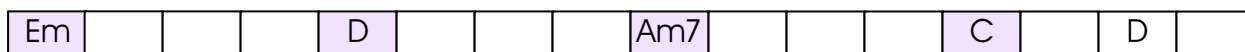

*repeat and fade this line*

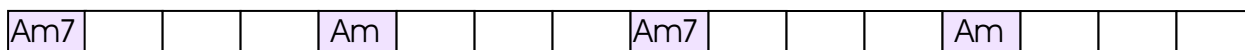

arrangement      verse - chorus - verse - chorus - <sup>solo</sup>verse - chorus - verse - coda

## exercise - 'G' minor (harmonic) scale

This time playing the scale should take less explanation, play this scale the same way as you did the 'G' major scale in the last lesson. Play the scale both ways this time, from the bottom to the top and then from the top to the bottom. Keep practising the 'G' major scale as well.

It is very important to use the correct fingers.

If you need to hear the scales, they can be listened to with the multimedia program provided with the course.

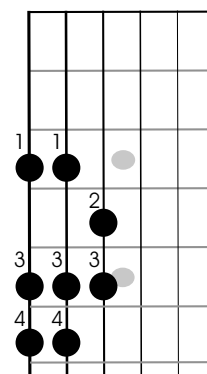

### Right

The thumb is in the center of the neck and the fingers are putting pressure on only the string required.



### Wrong

The thumb is around the neck and the fingers are laying against strings which are not intended to be played.

### Note

In both cases you can see how the fingers naturally sit in a position above the correct frets. This is why you should use the correct fingers.

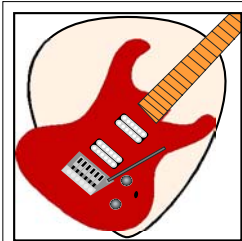

# month one

## Week Four

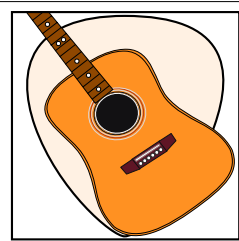

### tune

Candle in the wind - Elton John

verse

G				G				C				D7			
G				C			G	C				C			
G				G				C				C			
G				C			G	C				C			

chorus

D				D				G				C			
G				G				D				D			
C				C				Em				Em			
D				C				C				C			

instrumental

G				G				D				D7			
G				D				C				G			

coda

Em				D				C				c			
----	--	--	--	---	--	--	--	---	--	--	--	---	--	--	--

Arrangement

verse - chorus - verse - chorus - instrumental - verse - chorus - coda

## exercise - 'G' minor pentatonic

Practice this scale the same way as you did the 'G' major scale and the 'G' minor natural scale in the last lesson. Play the scale both ways, from the bottom to the top and then from the top to the bottom.

It is very important to use the correct fingers.

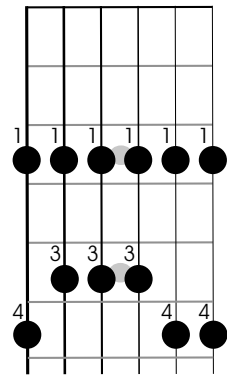

### Revision

Play these scales until you can remember them.

The open chords will naturally re-occur as you play more tunes, therefore it isn't as important to memorize them, however the scales will only be used in relation to theory, so you may forget them if you don't practise them regularly. A second advantage in practising your scales is that, when we start learning lead guitar techniques, your fingers will already be adept at playing single notes.

'G' major

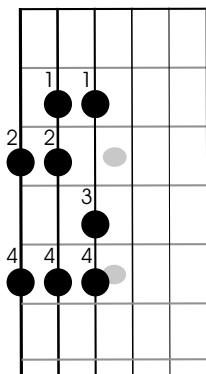

'G' minor harmonic

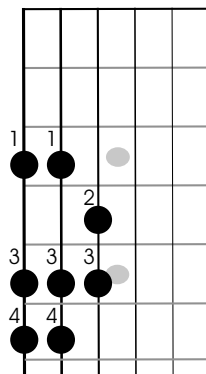

'G' minor pentatonic

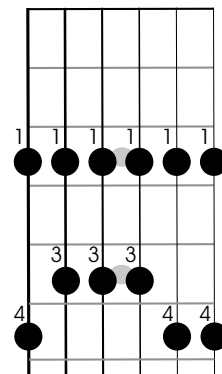

### End of the free first month

I hope you have enjoyed your first months lessons from the GCH guitar academy. I am sure you will have got something out of it. This is a highly structured course which takes students from absolute beginners through to professional performing musicians, step by step. If you would like more information about the course or would like to continue, visit the WEB site.

[www.guitar-academy.com](http://www.guitar-academy.com)



The GCH Guitar Academy course has been developed over more than fifteen years to get the best possible results from its students. This multimedia course is the latest way to learn how to play the guitar. The lessons are interactive with sound and video to help you every step of the way.

**lessons consist of**  
 printable e-books  
 interactive lessons  
 backing tracks

**Also on this CD**  
 guitar tuner  
 metronome  
 interactive chord chart  
 backing track player

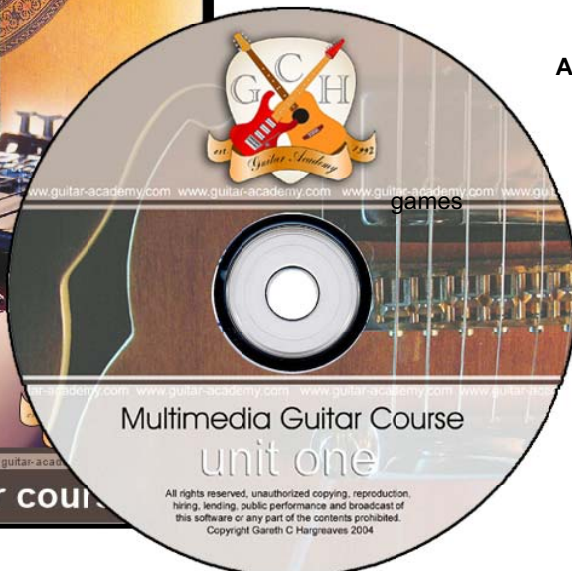

All rights reserved, unauthorized changing or selling, of this document or any part of the contents is prohibited by law without prior consent from the owner.

Copyright Gareth C Hargreaves 2004